

**HEXFET® POWER MOSFET  
 SURFACE MOUNT (SMD-0.5)**

**IRF5NJ3315  
 150V, N-CHANNEL**

**Product Summary**

Part Number	BV <sub>DSS</sub>	R <sub>DS(on)</sub>	I <sub>D</sub>
IRF5NJ3315	150V	0.08Ω	20A

Fifth Generation HEXFET® power MOSFETs from International Rectifier utilize advanced processing techniques to achieve the lowest possible on-resistance per silicon unit area. This benefit, combined with the fast switching speed and ruggedized device design that HEXFET power MOSFETs are well known for, provides the designer with an extremely efficient device for use in a wide variety of applications.

These devices are well-suited for applications such as switching power supplies, motor controls, inverters, choppers, audio amplifiers and high-energy pulse circuits.

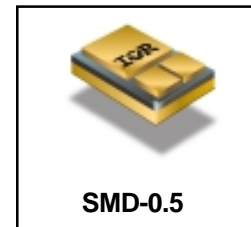

**SMD-0.5**

**Features:**

- Low R<sub>DS(on)</sub>
- Avalanche Energy Ratings
- Dynamic dv/dt Rating
- Simple Drive Requirements
- Ease of Paralleling
- Hermetically Sealed
- Surface Mount
- Light Weight

**Absolute Maximum Ratings**

	Parameter		Units
I <sub>D</sub> @ V <sub>GS</sub> = -10V, T <sub>C</sub> = 25°C	Continuous Drain Current	20	A
I <sub>D</sub> @ V <sub>GS</sub> = -10V, T <sub>C</sub> = 100°C	Continuous Drain Current	12	
I <sub>DM</sub>	Pulsed Drain Current ①	80	
P <sub>D</sub> @ T <sub>C</sub> = 25°C	Max. Power Dissipation	75	W
	Linear Derating Factor	0.6	W/°C
V <sub>GS</sub>	Gate-to-Source Voltage	±20	V
EAS	Single Pulse Avalanche Energy ②	165	mJ
I <sub>AR</sub>	Avalanche Current ①	12	A
EAR	Repetitive Avalanche Energy ①	7.5	mJ
dv/dt	Peak Diode Recovery dv/dt ③	3.0	V/ns
T <sub>J</sub>	Operating Junction	-55 to 150	°C
T <sub>STG</sub>	Storage Temperature Range		
	Package Mounting Surface Temperature	300 (for 5 s)	
	Weight	1.0 (Typical)	g

For footnotes refer to the last page

**Electrical Characteristics @ T<sub>j</sub> = 25°C (Unless Otherwise Specified)**

	Parameter	Min	Typ	Max	Units	Test Conditions
BV <sub>DSS</sub>	Drain-to-Source Breakdown Voltage	150	—	—	V	V <sub>GS</sub> = 0V, I <sub>D</sub> = 250μA
ΔBV <sub>DSS</sub> /ΔT <sub>J</sub>	Temperature Coefficient of Breakdown Voltage	—	0.18	—	V/°C	Reference to 25°C, I <sub>D</sub> = 1.0mA
R <sub>DSON</sub>	Static Drain-to-Source On-State Resistance	—	—	0.08	Ω	V <sub>GS</sub> = 10V, I <sub>D</sub> = 12A ④
V <sub>GS(th)</sub>	Gate Threshold Voltage	2.0	—	4.0	V	V <sub>DS</sub> = V <sub>GS</sub> , I <sub>D</sub> = 250μA
g <sub>fs</sub>	Forward Transconductance	12	—	—	S (r)	V <sub>DS</sub> = 15V, I <sub>DS</sub> = 12A ④
I <sub>DSS</sub>	Zero Gate Voltage Drain Current	—	—	25	μA	V <sub>DS</sub> = 150V, V <sub>GS</sub> = 0V
		—	—	250		V <sub>DS</sub> = 120V, V <sub>GS</sub> = 0V, T <sub>J</sub> = 125°C
I <sub>GSS</sub>	Gate-to-Source Leakage Forward	—	—	100	nA	V <sub>GS</sub> = 20V
I <sub>GSS</sub>	Gate-to-Source Leakage Reverse	—	—	-100		V <sub>GS</sub> = -20V
Q <sub>g</sub>	Total Gate Charge	—	—	95	nC	V <sub>GS</sub> = 10V, I <sub>D</sub> = 12A
Q <sub>gs</sub>	Gate-to-Source Charge	—	—	11		V <sub>DS</sub> = 120V
Q <sub>gd</sub>	Gate-to-Drain ('Miller') Charge	—	—	47		
t <sub>d(on)</sub>	Turn-On Delay Time	—	—	25	ns	V <sub>DD</sub> = 75V, I <sub>D</sub> = 12A, V <sub>GS</sub> = 10V, R <sub>G</sub> = 5.1Ω
t <sub>r</sub>	Rise Time	—	—	60		
t <sub>d(off)</sub>	Turn-Off Delay Time	—	—	75		
t <sub>f</sub>	Fall Time	—	—	60		
L <sub>S</sub> + L <sub>D</sub>	Total Inductance	—	4.0	—	nH	Measured from the center of drain pad to center of source pad
C <sub>iss</sub>	Input Capacitance	—	1370	—	pF	V <sub>GS</sub> = 0V, V <sub>DS</sub> = 25V f = 1.0MHz
C <sub>oss</sub>	Output Capacitance	—	300	—		
C <sub>rss</sub>	Reverse Transfer Capacitance	—	160	—		

**Source-Drain Diode Ratings and Characteristics**

	Parameter	Min	Typ	Max	Units	Test Conditions
I <sub>S</sub>	Continuous Source Current (Body Diode)	—	—	20	A	
I <sub>SM</sub>	Pulse Source Current (Body Diode) ①	—	—	80		
V <sub>SD</sub>	Diode Forward Voltage	—	—	1.3	V	T <sub>j</sub> = 25°C, I <sub>S</sub> = 12A, V <sub>GS</sub> = 0V ④
t <sub>rr</sub>	Reverse Recovery Time	—	—	260	ns	T <sub>j</sub> = 25°C, I <sub>F</sub> = 12A, di/dt ≤ 100A/μs
Q <sub>RR</sub>	Reverse Recovery Charge	—	—	1.7	μC	V <sub>DD</sub> ≤ 25V ④
t <sub>on</sub>	Forward Turn-On Time	Intrinsic turn-on time is negligible. Turn-on speed is substantially controlled by L <sub>S</sub> + L <sub>D</sub> .				

**Thermal Resistance**

	Parameter	Min	Typ	Max	Units	Test Conditions
R <sub>thJC</sub>	Junction-to-Case	—	—	1.67	°C/W	

Note: Corresponding Spice and Saber models are available on the G&S Website.

For footnotes refer to the last page

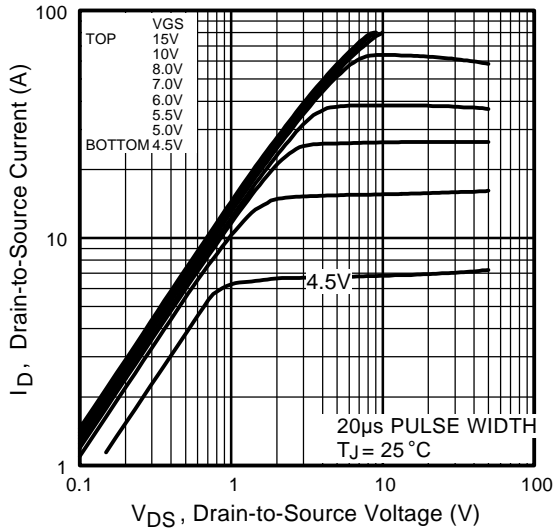

**Fig 1.** Typical Output Characteristics

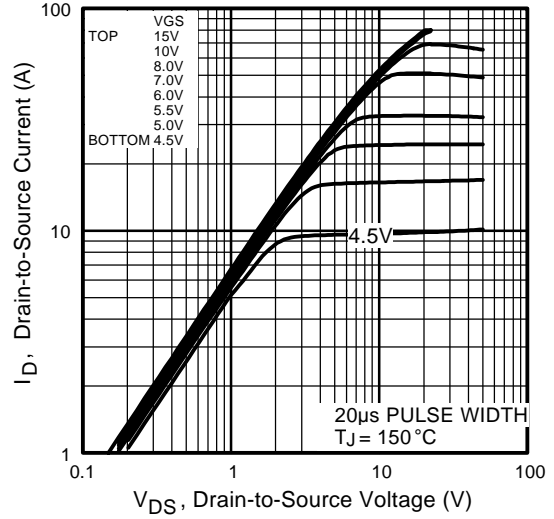

**Fig 2.** Typical Output Characteristics

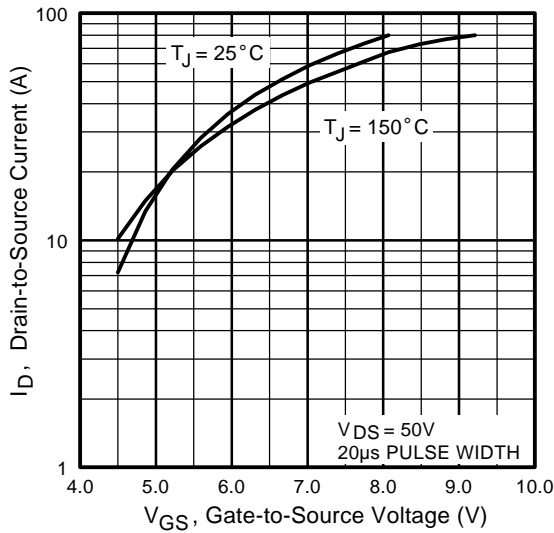

**Fig 3.** Typical Transfer Characteristics

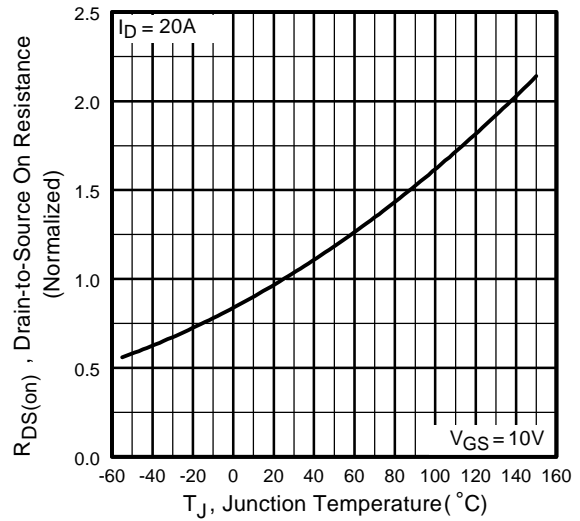

**Fig 4.** Normalized On-Resistance Vs. Temperature

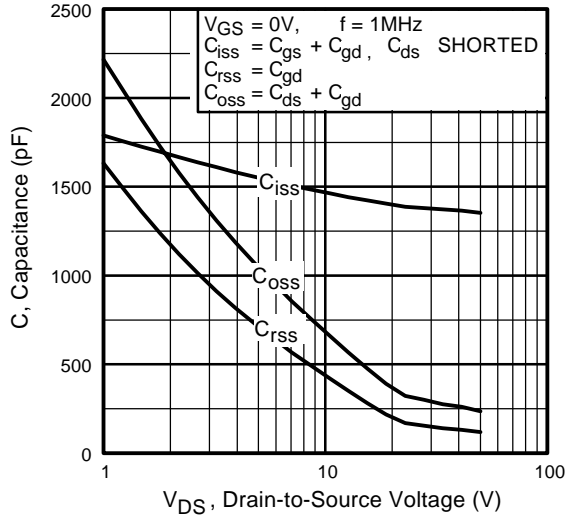

**Fig 5.** Typical Capacitance Vs. Drain-to-Source Voltage

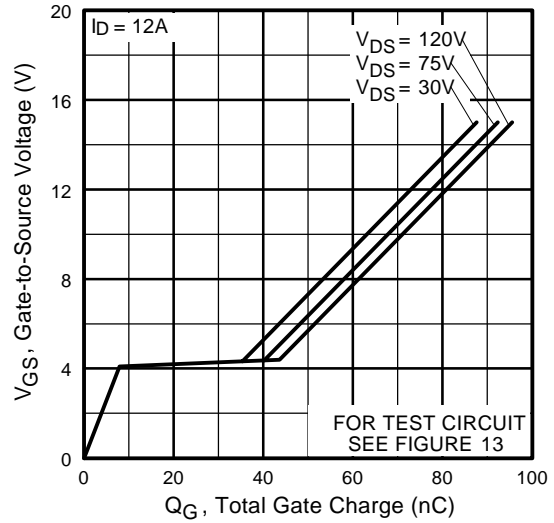

**Fig 6.** Typical Gate Charge Vs. Gate-to-Source Voltage

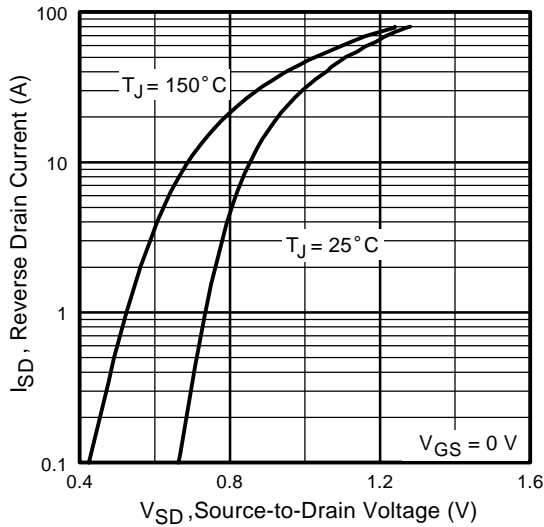

**Fig 7.** Typical Source-Drain Diode Forward Voltage

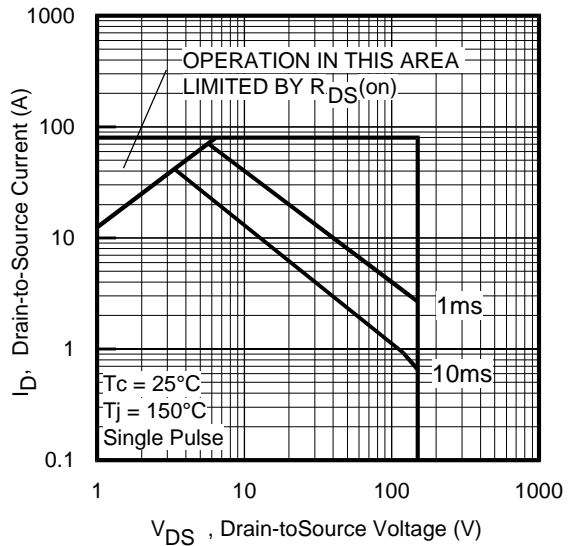

**Fig 8.** Maximum Safe Operating Area

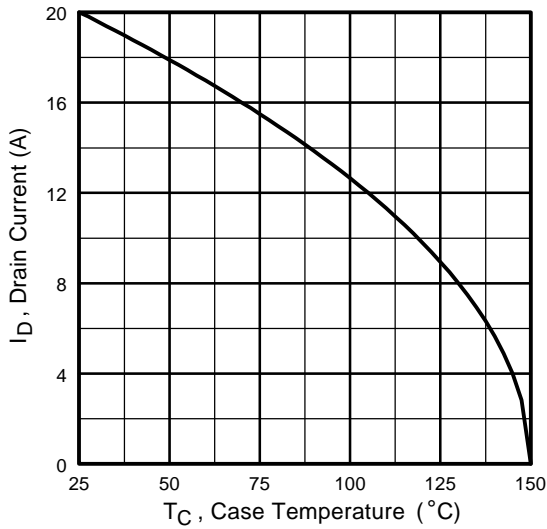

**Fig 9.** Maximum Drain Current Vs. Case Temperature

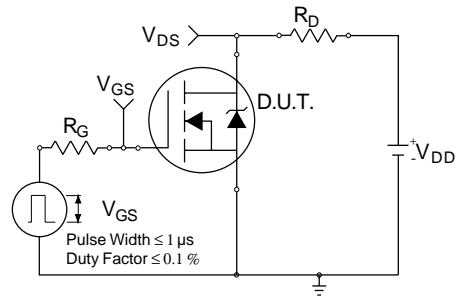

**Fig 10a.** Switching Time Test Circuit

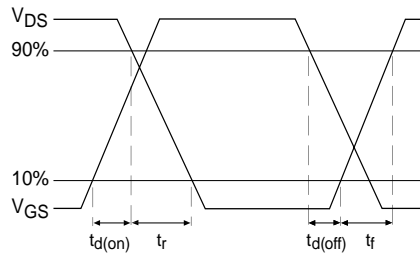

**Fig 10b.** Switching Time Waveforms

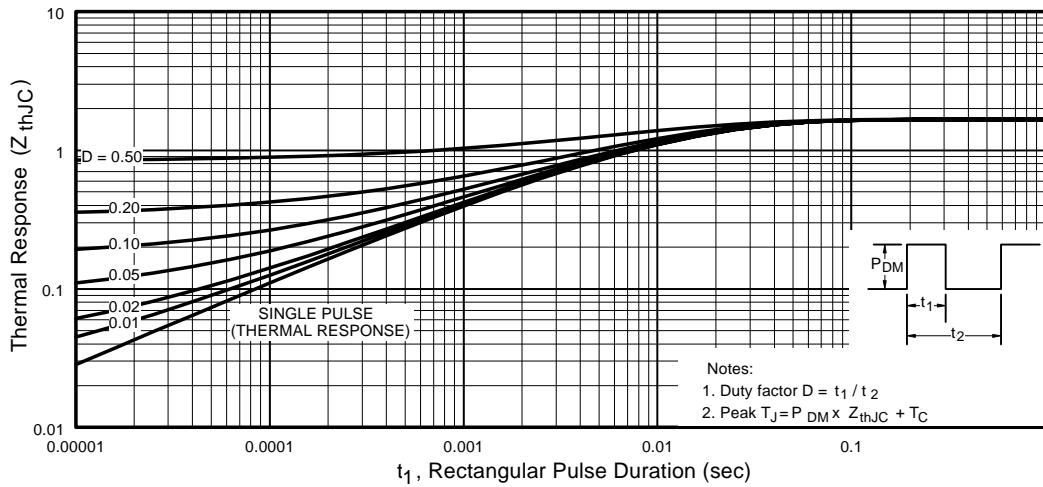

**Fig 11.** Maximum Effective Transient Thermal Impedance, Junction-to-Case

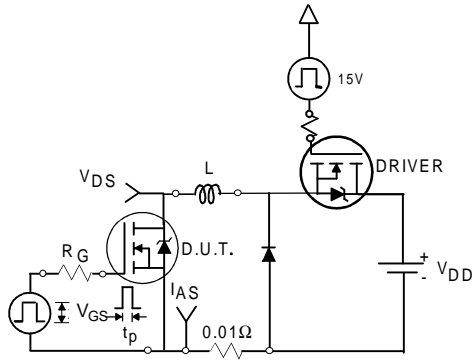

**Fig 12a.** Unclamped Inductive Test Circuit

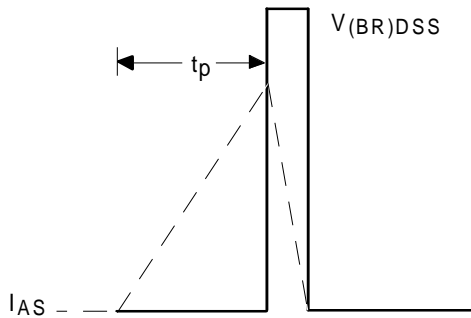

**Fig 12b.** Unclamped Inductive Waveforms

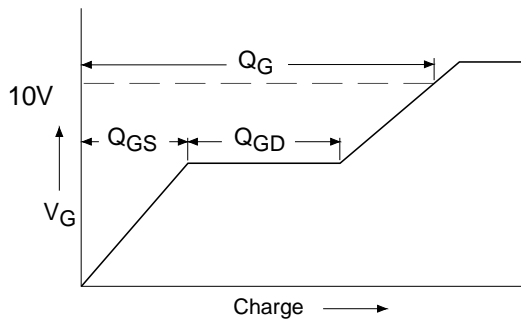

**Fig 13a.** Basic Gate Charge Waveform

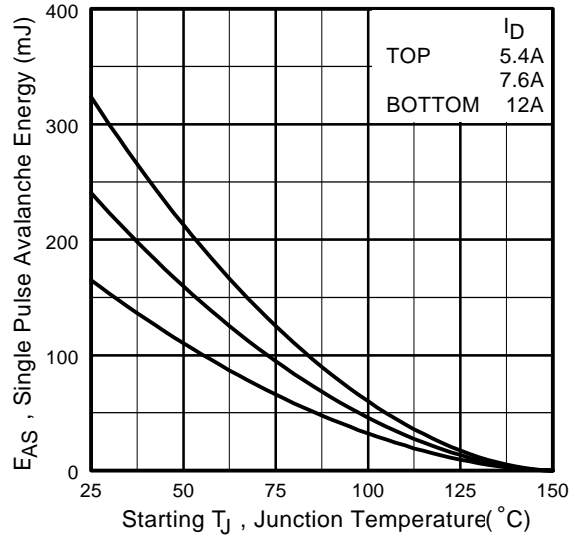

**Fig 12c.** Maximum Avalanche Energy Vs. Drain Current

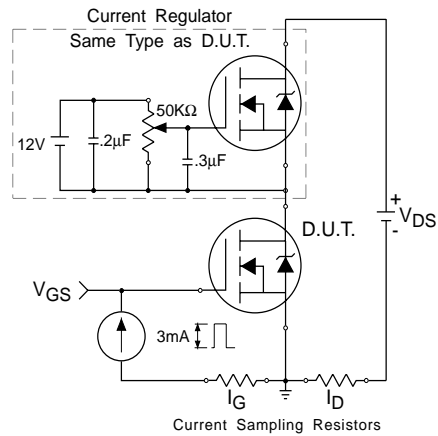
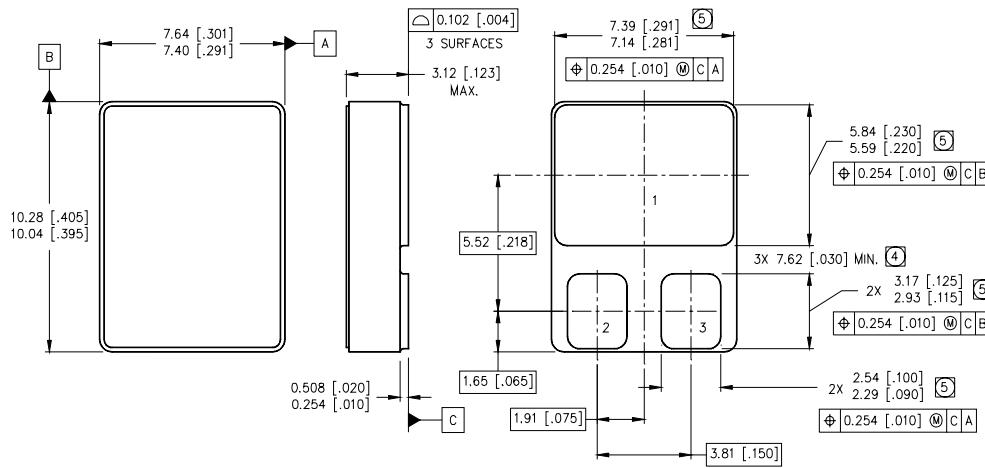

**Fig 13b.** Gate Charge Test Circuit

**Footnotes:**

- ① Repetitive Rating; Pulse width limited by maximum junction temperature.
- ②  $V_{DD} = 50\text{ V}$ , Starting  $T_J = 25^\circ\text{C}$ ,  $L = 2.3\text{mH}$   
 Peak  $I_{AS} = 12\text{A}$ ,  $V_{GS} = 10\text{ V}$ ,  $R_G = 25\Omega$
- ③  $I_{SD} \leq 12\text{A}$ ,  $di/dt \leq 120\text{ A}/\mu\text{s}$ ,  
 $V_{DD} \leq 150\text{V}$ ,  $T_J \leq 150^\circ\text{C}$
- ④ Pulse width  $\leq 300\ \mu\text{s}$ ; Duty Cycle  $\leq 2\%$

**Case Outline and Dimensions — SMD-0.5**



**NOTES:**

1. DIMENSIONING & TOLERANCING PER ASME Y14.5M-1994.
2. CONTROLLING DIMENSION: INCH.
3. DIMENSIONS ARE SHOWN IN MILLIMETERS [INCHES].
- ④ DIMENSION INCLUDES METALLIZATION FLASH.
- ⑤ DIMENSION DOES NOT INCLUDE METALLIZATION FLASH.

**PAD ASSIGNMENTS**

- 1 = DRAIN
- 2 = GATE
- 3 = SOURCE